

USER MANUAL



CONTENTS

1. SAFETY INFORMATION.....	2
2. SAFETY INSTRUCTIONS.....	4
3. PRODUCT DESCRIPTION.....	7
4. DAILY USE.....	9
5. HINTS AND TIPS.....	11
6. CARE AND CLEANING.....	12
7. TROUBLESHOOTING.....	13
8. INSTALLATION.....	15
9. TECHNICAL DATA.....	16
10. ENERGY EFFICIENCY.....	16

FOR PERFECT RESULTS

Thank you for choosing this AEG product. We have created it to give you impeccable performance for many years, with innovative technologies that help make life simpler features you might not find on ordinary appliances. Please spend a few minutes reading to get the very best from it.

Visit our website for:



Get usage advice, brochures, trouble shooter, service information:
www.aeg.com/webselfservice



Register your product for better service:
www.registeraeg.com



Buy Accessories, Consumables and Original spare parts for your appliance:
www.aeg.com/shop

CUSTOMER CARE AND SERVICE

Always use original spare parts.

When contacting our Authorised Service Centre, ensure that you have the following data available: Model, PNC, Serial Number.

The information can be found on the rating plate.

 Warning / Caution-Safety information

 General information and tips

 Environmental information

Subject to change without notice.

1. SAFETY INFORMATION

Before the installation and use of the appliance, carefully read the supplied instructions. The manufacturer is not responsible for any injuries or damages that are the result of incorrect installation or

usage. Always keep the instructions in a safe and accessible location for future reference.

1.1 Children and vulnerable people safety

- This appliance can be used by children aged from 8 years and above and persons with reduced physical, sensory or mental capabilities or lack of experience and knowledge if they have been given supervision or instruction concerning the use of the appliance in a safe way and understand the hazards involved.
- Do not let children play with the appliance.
- Keep all packaging away from children and dispose of it appropriately.
- Keep children and pets away from the appliance when it operates or when it cools down. Accessible parts are hot.
- If the appliance has a child safety device, this should be activated.
- Children shall not carry out cleaning and user maintenance of the appliance without supervision.
- Children aged 3 years and under must be kept away from this appliance when it is in operation at all times.

1.2 General Safety

- **WARNING:** The appliance and its accessible parts become hot during use. Care should be taken to avoid touching heating elements. Children less than 8 years of age shall be kept away unless continuously supervised.
- Do not operate the appliance by means of an external timer or separate remote-control system.
- **WARNING:** Unattended cooking on a hob with fat or oil can be dangerous and may result in fire.
- **NEVER** try to extinguish a fire with water, but switch off the appliance and then cover flame e.g. with a lid or a fire blanket.

- **CAUTION:** The cooking process has to be supervised. A short term cooking process has to be supervised continuously.
- **WARNING:** Danger of fire: Do not store items on the cooking surfaces.
- Metallic objects such as knives, forks, spoons and lids should not be placed on the hob surface since they can get hot.
- Do not use a steam cleaner to clean the appliance.
- If the glass ceramic surface / glass surface is cracked, switch off the appliance to avoid the possibility of electric shock.
- If the supply cord is damaged, it must be replaced by the manufacturer, an authorized Service or similarly qualified persons in order to avoid a hazard.
- **WARNING:** Use only hob guards designed by the manufacturer of the cooking appliance or indicated by the manufacturer of the appliance in the instructions for use as suitable or hob guards incorporated in the appliance. The use of inappropriate guards can cause accidents.

2. SAFETY INSTRUCTIONS

2.1 Installation



WARNING!

Only a qualified person must install this appliance.



WARNING!

Risk of injury or damage to the appliance.

- Remove all the packaging.
- Do not install or use a damaged appliance.
- Follow the installation instruction supplied with the appliance.
- Keep the minimum distance from the other appliances and units.
- Always take care when moving the appliance as it is heavy. Always use safety gloves and enclosed footwear.
- Seal the cut surfaces with a sealant to prevent moisture to cause swelling.
- Protect the bottom of the appliance from steam and moisture.
- Do not install the appliance adjacent to a door or under a window. This prevents hot cookware to fall from the appliance when the door or the window is opened.
- If the appliance is installed above drawers make sure that the space, between the bottom of the appliance and the upper drawer, is sufficient for air circulation.
- The bottom of the appliance can get hot. Make sure to install a separation panel made from plywood, kitchen carcass material or other non-flammable materials under the appliance to prevent access to the bottom.

2.2 Electrical Connection



WARNING!

Risk of fire and electrical shock.

- All electrical connections should be made by a qualified electrician.
- The appliance must be earthed.
- Before carrying out any operation make sure that the appliance is disconnected from the power supply.
- Make sure that the parameters on the rating plate are compatible with the electrical ratings of the mains power supply.
- Make sure the appliance is installed correctly. Loose and incorrect electricity mains cable or plug (if applicable) can make the terminal become too hot.
- Use the correct electricity mains cable.
- Do not let the electricity mains cable tangle.
- Make sure that a shock protection is installed.
- Use the strain relief clamp on the cable.
- Make sure the mains cable or plug (if applicable) does not touch the hot appliance or hot cookware, when you connect the appliance to the near sockets
- Do not use multi-plug adapters and extension cables.
- Make sure not to cause damage to the mains plug (if applicable) or to the mains cable. Contact our Authorised Service Centre or an electrician to change a damaged mains cable.
- The shock protection of live and insulated parts must be fastened in such a way that it cannot be removed without tools.
- Connect the mains plug to the mains socket only at the end of the installation. Make sure that there is access to the mains plug after the installation.
- If the mains socket is loose, do not connect the mains plug.
- Do not pull the mains cable to disconnect the appliance. Always pull the mains plug.

- Use only correct isolation devices: line protecting cut-outs, fuses (screw type fuses removed from the holder), earth leakage trips and contactors.
- The electrical installation must have an isolation device which lets you disconnect the appliance from the mains at all poles. The isolation device must have a contact opening width of minimum 3 mm.

2.3 Use



WARNING!

Risk of injury, burns and electrical shock.

- Remove all the packaging, labelling and protective film (if applicable) before first use.
 - Use this appliance in a household environment.
 - Do not change the specification of this appliance.
 - Make sure that the ventilation openings are not blocked.
 - Do not let the appliance stay unattended during operation.
 - Set the cooking zone to "off" after each use.
 - Do not put cutlery or saucepan lids on the cooking zones. They can become hot.
 - Do not operate the appliance with wet hands or when it has contact with water.
 - Do not use the appliance as a work surface or as a storage surface.
 - If the surface of the appliance is cracked, disconnect immediately the appliance from the power supply. This to prevent an electrical shock.
 - When you place food into hot oil, it may splash.
-  **WARNING!**
Risk of fire and explosion
- Fats and oil when heated can release flammable vapours. Keep flames or heated objects away from fats and oils when you cook with them.
 - The vapours that very hot oil releases can cause spontaneous combustion.
 - Used oil, that can contain food remnants, can cause fire at a lower

temperature than oil used for the first time.

- Do not put flammable products or items that are wet with flammable products in, near or on the appliance.



WARNING!

Risk of damage to the appliance.

- Do not keep hot cookware on the control panel.
- Do not put a hot pan cover on the glass surface of the hob.
- Do not let cookware to boil dry.
- Be careful not to let objects or cookware fall on the appliance. The surface can be damaged.
- Do not activate the cooking zones with empty cookware or without cookware.
- Do not put aluminium foil on the appliance.
- Cookware made of cast iron, aluminium or with a damaged bottom can cause scratches on the glass / glass ceramic. Always lift these objects up when you have to move them on the cooking surface.
- This appliance is for cooking purposes only. It must not be used for other purposes, for example room heating.

2.4 Care and cleaning

- Clean regularly the appliance to prevent the deterioration of the surface material.

- Deactivate the appliance and let it cool down before you clean it.
- Disconnect the appliance from the electrical supply before maintenance.
- Do not use water spray and steam to clean the appliance.
- Clean the appliance with a moist soft cloth. Only use neutral detergents. Do not use any abrasive products, abrasive cleaning pads, solvents or metal objects.

2.5 Disposal



WARNING!

Risk of injury or suffocation.

- Contact your municipal authority for information on how to discard the appliance correctly.
- Disconnect the appliance from the mains supply.
- Cut off the mains electrical cable close to the appliance and dispose of it.

2.6 Service

- To repair the appliance contact an Authorised Service Centre.
- Use original spare parts only.

3. PRODUCT DESCRIPTION

3.1 Cooking surface layout

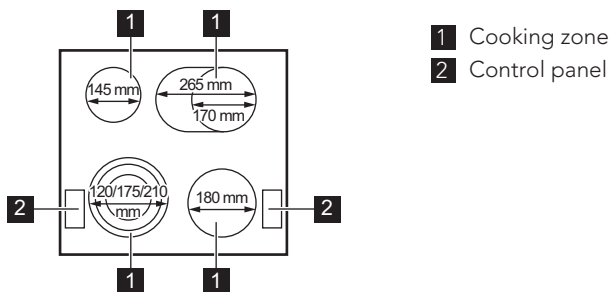



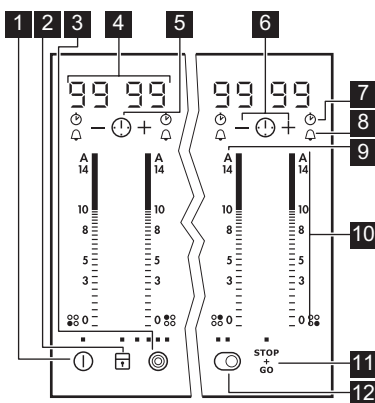



3.2 Control panel layout











Use the sensor fields to operate the appliance. The displays, indicators and sounds tell which functions operate.

Sensor field	Function	Comment
1	ⓘ	ON / OFF To activate and deactivate the hob.
2	🔒	Lock / The Child Safety Device To lock / unlock the control panel.
3	🌀	- To activate and deactivate the outer ring.
4	-	Heat setting and timer display To show the heat setting and time in minutes.

Sensor field	Function	Comment
5 	-	To set the timer function.
6 	-	To increase or decrease the time.
7 	CountUp Timer	To show that the function operates.
8 	Count Down Timer / Minute Minder	To show that the function operates.
9 	Automatic Heat Up	To activate and deactivate the function.
10 -	Control bar	To set a heat setting.
11 	STOP+GO	To activate and deactivate the function.
12 	-	To activate and deactivate the outer ring.

3.3 Heat setting displays

Display	Description
	The cooking zone is deactivated.
	The cooking zone operates.
	STOP+GO function operates.
	Automatic Heat Up function operates.
	There is a malfunction.
	OptiHeat Control (3 step Residual heat indicator): continue cooking / keep warm / residual heat.
	Lock / The Child Safety Device function operates.
	Automatic Switch Off function operates.

3.4 OptiHeat Control (3 step Residual heat indicator)



WARNING!

 There is a risk of burns from residual heat. The indicator shows the level of the residual heat.

4. DAILY USE



WARNING!
Refer to Safety chapters.

4.1 Activating and deactivating

Touch  for 1 second to activate or deactivate the hob.

4.2 Automatic Switch Off

The function deactivates the hob automatically if:

- all cooking zones are deactivated,
- you do not set the heat setting after you activate the hob,
- you spill something or put something on the control panel for more than 10 seconds (a pan, a cloth, etc.). An acoustic signal sounds and the hob deactivates. Remove the object or clean the control panel.
- you do not deactivate a cooking zone or change the heat setting. After some time  comes on and the hob deactivates.

The relation between the heat setting and the time after which the hob deactivates:

Heat setting	The hob deactivates after
 1 - 3	6 hours
4 - 7	5 hours
8 - 9	4 hours
10 - 14	1.5 hour

4.3 The heat setting

To set or change the heat setting:

Touch the control bar at the correct heat setting or move your finger along the control bar until you reach the correct heat setting.

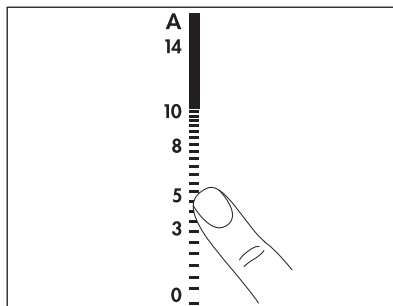

4.4 Activating and deactivating the outer rings

You can adjust the surface you cook to the dimension of the cookware.

Use sensor field: 

To activate the outer ring: touch the sensor field. The indicator comes on.

To activate more outer rings: touch the same sensor field again. The subsequent indicator comes on.

To deactivate the outer ring: touch the sensor field until the indicator goes out.



When you activate the zone but do not activate the outer ring the light that comes out from the zone may cover the outer ring. It does not mean that the outer ring is activated. To see if the ring is activated check the indicator.

4.5 Automatic Heat Up

Activate this function to get a desired heat setting in a shorter time. When it is on, the zone operates on the highest setting in the beginning and then continues to cook at the desired heating setting.



To activate the function the cooking zone must be cold.

To activate the function for a cooking zone: touch **A**  (comes on).

Immediately touch a desired heat setting. After 3 seconds  comes on.

To deactivate the function: change the heat setting.

4.6 Timer





You can set one timer function for each cooking zone separately. To set a timer function for the zones on the left side use the timer on the left, for the zones on the right, the timer on the right.

Count Down Timer

Use this function to specify how long a cooking zone should operate during a single cooking session.

First set the heat setting for the cooking zone and then set the function.



To activate the function or change the

time: touch  quickly again and again until the indicator  of a given zone lights up on the display. Then touch  or  to set the time (00 - 99 minutes). The function starts automatically after 4 seconds.  comes on the display.

To activate the timer function for the second zone in a pair touch  3 times quickly.



When the time comes to an end, a signal sounds and 00 flashes. Touch  to stop the signal.

To see the remaining time: touch .

To deactivate the function: choose the desired zone touching  and then touch . The remaining time counts back to 00. The symbol  goes out.

CountUp Timer (The count up timer)



You can use this function to monitor how long a cooking zone operates.

To activate the function: for the first zone in a pair touch  twice quickly. The function starts automatically when  lights up. To activate the function for the

second zone in a pair touch  4 times quickly.



To see how long the cooking zone



operates: touch . The display shows the time, at first in seconds then in minutes.

To deactivate the function: choose the desired zone touching  and then touch . The symbol  goes out.

Minute Minder

You can use this function as a **Minute Minder** when the hob is activated but the cooking zones do not operate.

To activate the function: touch  quickly again and again until the indicator  of a given zone lights up on the display.

Touch  or  to set the time. The function starts automatically after 4 seconds.  comes on the display.

When the time comes to an end, a signal sounds and 00 flashes. Touch  to stop the signal.

 The function has no effect on the operation of the cooking zones.

4.7 STOP+GO

This function sets all cooking zones that operate to the lowest heat setting.

When the function operates, you cannot change the heat setting.

The function does not stop the timer functions.



To activate the function: touch  comes on.

To deactivate the function: touch . The previous heat setting comes on.

4.8 Lock

You can lock the control panel while cooking zones operate. It prevents an accidental change of the heat setting.

Set the heat setting first.





To activate the function: touch   comes on for 4 seconds. The Timer stays on.





To deactivate the function: touch . The previous heat setting comes on.



 When you deactivate the hob, you also deactivate this function.

4.9 The Child Safety Device

This function prevents an accidental operation of the hob.





To activate the function: activate the hob with . Do not set the heat setting. Touch  for 4 seconds.  comes on. Deactivate the hob with .



To deactivate the function: activate the hob with . Do not set the heat setting. Touch  for 4 seconds.  comes on. Deactivate the hob with .

To override the function for only one cooking time: activate the hob with .  comes on. Touch  for 4 seconds.

Set the heat setting in 10 seconds. You can operate the hob. When you deactivate the hob with  the function operates again.

4.10 OffSound Control (Deactivating and activating the sounds)

Deactivate the hob. Touch  for 3 seconds. The display comes on and goes out. Touch  for 3 seconds.  or  comes on. Touch  of the timer to choose one of the following:

-  - the sounds are off
 -  - the sounds are on
- To confirm your selection wait until the hob deactivates automatically.

When the function is set to  you can hear the sounds only when:

- you touch 
- Minute Minder comes down
- Count Down Timer comes down
- you put something on the control panel.

5. HINTS AND TIPS



WARNING!
Refer to Safety chapters.

5.1 Cookware



The bottom of the cookware must be as thick and flat as possible.



Cookware made of enamelled steel and with aluminium or copper bottoms can cause the colour change on the glass-ceramic surface.

5.2 Öko Timer (Eco Timer)

To save energy, the heater of the cooking zone deactivates before the count down timer sounds. The difference in the operation time depends on the heat setting level and the length of the cooking operation.

5.3 Examples of cooking applications



The data in the table is for guidance only.

Heat setting	Use to:	Time (min)	Hints
 - 1	Keep cooked food warm.	as necessary	Put a lid on the cookware.
1 - 3	Hollandaise sauce, melt: butter, chocolate, gelatine.	5 - 25	Mix from time to time.
1 - 3	Solidify: fluffy omelettes, baked eggs.	10 - 40	Cook with a lid on.
3 - 5	Simmer rice and milkbased dishes, heating up ready-cooked meals.	25 - 50	Add the minimum twice as much liquid as rice, mix milk dishes part procedure through.
5 - 7	Steam vegetables, fish, meat.	20 - 45	Add some tablespoons of liquid.
7 - 9	Steam potatoes.	20 - 60	Use max. ¼ l water for 750 g of potatoes.
7 - 9	Cook larger quantities of food, stews and soups.	60 - 150	Up to 3 l liquid plus ingredients.
9 - 12	Gentle fry: escalope, veal cordon bleu, cutlets, rissoles, sausages, liver, roux, eggs, pancakes, doughnuts.	as necessary	Turn halfway through.
12 - 13	Heavy fry, hash browns, loin steaks, steaks.	5 - 15	Turn halfway through.
14	Boil water, cook pasta, sear meat (goulash, pot roast), deep-fry chips.		

6. CARE AND CLEANING



WARNING!

Refer to Safety chapters.

6.1 General information

- Clean the hob after each use.
- Always use cookware with clean bottom.
- Scratches or dark stains on the surface have no effect on how the hob operates.
- Use a special cleaner applicable for the surface of the hob.
- Use a special scraper for the glass.

6.2 Cleaning the hob

- **Remove immediately:** melted plastic, plastic foil, sugar and food with sugar. If not, the dirt can cause damage to the hob. Take care to avoid burns. Put the special scraper on the glass surface at an acute angle and move the blade on the surface.
- **Remove when the hob is sufficiently cool:** limescale rings, water rings, fat stains, shiny metallic discoloration. Clean the hob with a moist cloth and non-abrasive detergent. After cleaning, wipe the hob dry with a soft cloth.
- **Remove shiny metallic discoloration:** use a solution of water

with vinegar and clean the glass surface with a moist cloth.

7. TROUBLESHOOTING







WARNING!

Refer to Safety chapters.

7.1 What to do if...

Problem	Possible cause	Remedy
You cannot activate or operate the hob.	The hob is not connected to an electrical supply or it is connected incorrectly.	Check if the hob is correctly connected to the electrical supply. Refer to the connection diagram.
	The fuse is blown.	Make sure that the fuse is the cause of the malfunction. If the fuse is blown again and again, contact a qualified electrician.
		Activate the hob again and set the heat setting in less than 10 seconds.
	You touched 2 or more sensor fields at the same time.	Touch only one sensor field.
	STOP+GO function operates.	Refer to "Daily use" chapter.
	There is water or fat stains on the control panel.	Clean the control panel.
An acoustic signal sounds and the hob deactivates. An acoustic signal sounds when the hob is deactivated.	You put something on one or more sensor fields.	Remove the object from the sensor fields.
The hob deactivates.	You put something on the sensor field ①.	Remove the object from the sensor field.
Residual heat indicator does not come on.	The zone is not hot because it operated only for a short time.	If the zone operated sufficiently long to be hot, speak to an Authorised Service Centre.
Automatic Heat Up function does not operate.	The zone is hot.	Let the zone become sufficiently cool.

Problem	Possible cause	Remedy
	The highest heat setting is set.	The highest heat setting has the same power as the function.
You cannot activate the outer ring.		Activate the inner ring first.
 There is a dark area on the multiple zone.	It is normal that there is a dark area on the multiple zone.	
The sensor fields become hot.	The cookware is too large or you put it too near to the controls.	Put large cookware on the rear zones if possible.
There is no signal when you touch the panel sensor fields.	The signals are deactivated.	Activate the signals. Refer to "Daily use" chapter.
 comes on.	Automatic Switch Off operates.	Deactivate the hob and activate it again.
 comes on.	The Child Safety Device or the Lock function operates.	Refer to "Daily use" chapter.
 and a number come on.	There is an error in the hob.	Disconnect the hob from the electrical supply for some time. Disconnect the fuse from the electrical system of the house. Connect it again. If  comes on again, speak to an Authorised Service Centre.
E6 comes on.	The second phase of the power supply is missing.	Check if the hob is correctly connected to the electrical supply. Remove the fuse, wait one minute, and insert the fuse again.

7.2 If you cannot find a solution...

If you cannot find a solution to the problem yourself, contact your dealer or an Authorised Service Centre. Give the data from the rating plate. Give also three digit letter code for the glass ceramic (it is in the corner of the glass

surface) and an error message that comes on. Make sure, you operated the hob correctly. If not the servicing by a service technician or dealer will not be free of charge, also during the warranty period. The instructions about the Service Centre and conditions of guarantee are in the guarantee booklet.

8. INSTALLATION



WARNING!
Refer to Safety chapters.

8.1 Before the installation

Before you install the hob, write down the information bellow from the rating plate. The rating plate is on the bottom of the hob.

Serial number

8.2 Built-in hobs

Only use the built-in hobs after you assemble the hob into correct built-in

8.4 Assembly

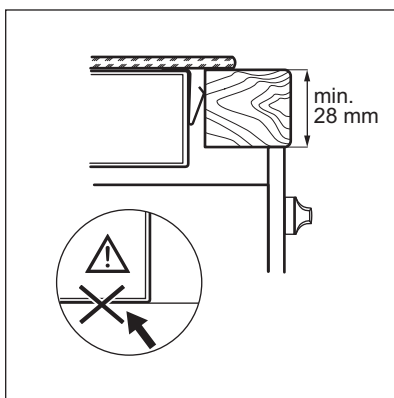
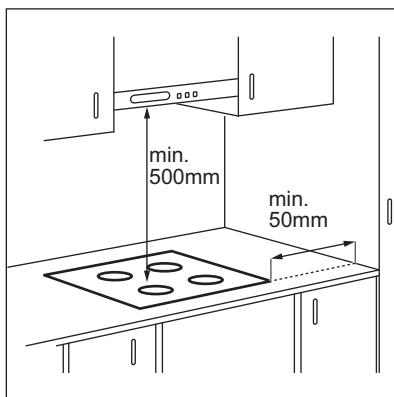

units and work surfaces that align to the standards.

8.3 Connection cable

- For a single phase or two phase connection, use the cable type: H05BB-F or H03V2V2-F which withstands a temperature of 70°C or higher.
- To replace the damaged mains cable, use the cable: H05BB-F or H03V2V2-F which withstands a temperature of 70°C or higher.

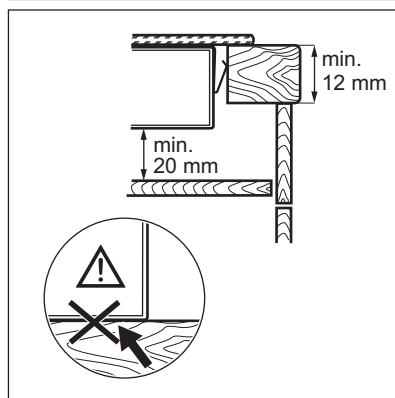
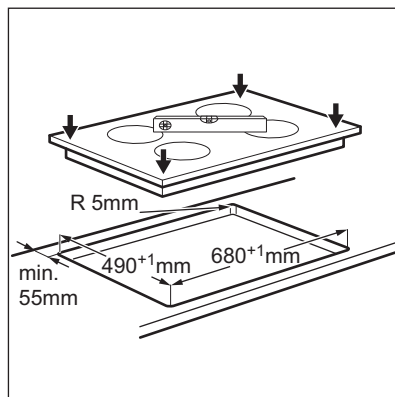

8.5 Protection box

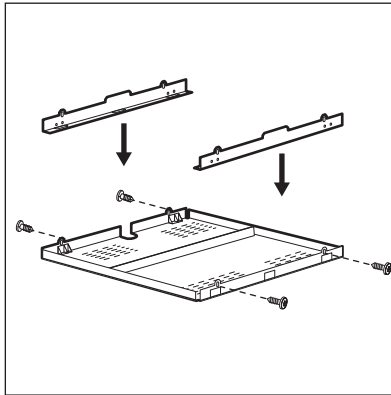

If you use a protection box (an additional accessory), the protective floor directly below the hob is not necessary. The protection box accessory may not be available in some countries. Please contact your local supplier.



You can not use the protection box if you install the hob above an oven.

9. TECHNICAL DATA

9.1 Rating plate

Model HK764070FB
Typ 60 HDD 70 AO

Ser.Nr.
AEG

PNC 949 597 194 00
220 - 240 V 50 - 60 Hz
Made in Germany
7.5 kW



9.2 Cooking zones specification

Cooking zone	Nominal Power (Max heat setting) [W]	Cooking zone diameter [mm]
Left front	800 / 1600 / 2300	120 / 175 / 210
Left rear	1200	145
Right front	1800	180
Right rear	1400 / 2200	170 / 265

For optimal cooking results use cookware not larger than the diameter of the cooking zone.

10. ENERGY EFFICIENCY

10.1 Product information according to EU 66/2014

Model identification	HK764070FB
----------------------	------------

Type of hob	Built-In Hob	
Number of cooking zones	4	
Heating technology	Radiant Heater	
Diameter of circular cooking zones (Ø)	Left front	21.0 cm
	Left rear	14.5 cm
	Right front	18.0 cm
Length (L) and width (W) of non circular cooking zone	Right rear	L 26.5 cm W 17.0 cm
Energy consumption per cooking zone (EC electric cooking)	Left front	174.3 Wh / kg
	Left rear	196.8 Wh / kg
	Right front	175.6 Wh / kg
	Right rear	176.8 Wh / kg
Energy consumption of the hob (EC electric hob)	180.9 Wh / kg	

EN 60350-2 - Household electric cooking appliances - Part 2: Hobs - Methods for measuring performance

10.2 Energy saving

You can save energy during everyday cooking if you follow below hints.

- When you heat up water, use only the amount you need.
- If it is possible, always put the lids on the cookware.

- Before you activate the cooking zone put the cookware on it.
- The cookware bottom should have the same diameter as the cooking zone.
- Put the smaller cookware on the smaller cooking zones.
- Put the cookware directly in the centre of the cooking zone.
- Use the residual heat to keep the food warm or to melt it.

11. ENVIRONMENTAL CONCERNS

Recycle the materials with the symbol . Put the packaging in applicable containers to recycle it. Help protect the environment and human health and to recycle waste of electrical and electronic appliances. Do not dispose appliances

marked with the symbol  with the household waste. Return the product to your local recycling facility or contact your municipal office.

www.aeg.com/shop



867 332791-A-492016



AEG